

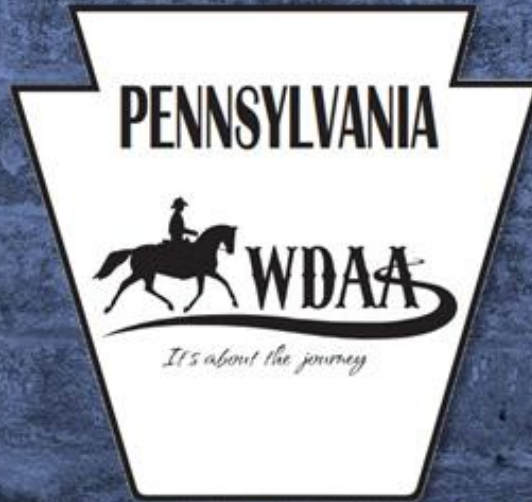

SPOTLIGHT
HORSE SHOWS

2026 US National Dressage Classic Qualifying Show

KEYSTONE



Summer Classic

Western, Classical, & Driven Dressage Online Show

WDAA, APHA-PAC, AWSSR, and FHANA Approved

Enter at SpotlightHorseShows.com



Entries Open Dates: June 5 - 28, 2026

Video Submission: through July 19

Results by: July 30

Enter at: SpotlightHorseShows.com

- WDAA Recognized: #26-181
- 2026 WDAA World Show Qualifier
- 2026 US National Dressage Classic Semi-Finals Qualifier



ONLINE COMPETITION SERIES

DRESSAGE • EVENTING DRESSAGE • WESTERN DRESSAGE

Our Judges*

Western Dressage: Lynn Newton (R)

Dressage & Eventing: Fran Kehr (S)

Driven Dressage: Larry Brinker (R)

*Additional judges may be added or changed as needed

Show Secretary – Gail Matheus

For show specific questions, contact Gail at Gail@SpotlightHorseShows.com

Quick Links

Click on the Topic to Jump to that Page

Arena Sizes

[Ridden Dressage Arenas](#)

[Sport Horse In-Hand](#)

[Driven Dressage Arenas](#)

Awards

[Show Awards](#)

[American Paint Horse – PAC Program](#)

[Friesian Horse Association of North America – Performance and Predicate Program](#)

[US National Dressage Classic](#)

[Western Dressage Association of America Programs](#)

Learn About Pivo

[Pivo Products](#)

[Pivo Filming Tips](#)

Enter A Show

[How To Enter on the Website](#)

[Video Signs & Video Upload](#)

[Video Approval & Test Sheets](#)

[Fees & Refund Policy](#)

[Rider Status](#)

Class Lists by Division

[Dressage](#)

[Eventing Dressage](#)

[Western Dressage](#)

Competition & Video Rules

[Dressage Rules](#)

[Western Dressage Rules](#)

[Driven Dressage Rules](#)

[Guidelines for Gaited Horses](#)

Donations & Sponsorships

[Community Outreach Programs](#)



Awards & Eligibility

Ribbons through 6th place will be awarded. Ties will not be broken

PAWDA Recognized/Virtual High Point

- A HORSE/RIDER PAIR MUST SUBMIT A TOTAL 3 TESTS FROM 2 DIFFERENT SHOWS
- SCORES MUST BE SUBMITTED FROM A MINIMUM 2 DIFFERENT JUDGES
- PLACING WILL BE DETERMINED BY AVERAGE SCORE
- SCORES MUST BE FROM SHOWS THAT ARE WDAA RECOGNIZED
- VISIT [PAWDA](#) FOR QUESTIONS AND MORE INFORMATION.



PAWDA Medal Program (membership required)

- PARTICIPANT MUST BE A CURRENT PAWDA MEMBER AT TIME SCORES ARE EARNED
- SCORES MAY COME FROM WDAA RECOGNIZED SHOWS, WDAA WORLD SHOW, USEF RECOGNIZED SHOWS OR SCHOOLING SHOWS
- VISIT [PAWDA](#) FOR QUESTIONS AND MORE INFORMATION.



US NATIONAL DRESSAGE CLASSIC SEMI-FINALS & NATIONAL FINALS

Riders are eligible to compete in the Semi-Finals for their home state.

See these pages for full details. Actual prizes may vary.

[Regions & Dates](#)

[Qualifying Scores](#)



WDAA HORSE LIFETIME POINT & YEAR END HIGH POINT PROGRAMS

Scores earned at this show count ½ points toward WDAA Horse Lifetime Points & Awards Program. It is optional to participate in this program. For more information, or to enroll in the program, please visit [WDAA Awards Program](#)

2026 WDAA WORLD QUALIFIER

See [Western Dressage Association of America's World Show Website](#) for show details.

The World Show will be held at the Lazy E Arena in Guthrie, OK

Dates: September 15-19, 2026

[Click this link to see Qualifying Dates and Requirements](#)

RECOGNITION – refer to their websites for details.



APHA-PAC



WDAA



Friesian Horse Assoc. of N.A.



American Warmblood Society

@pivo equestrian

Official Training Technology Partner



Record **Virtual Competitions**

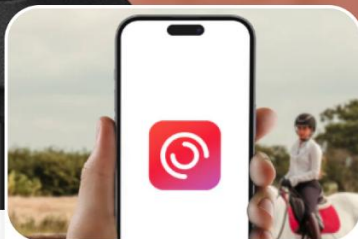

One App,
Total Control

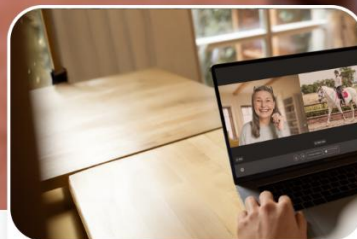

Easy **Remote Lessons**



Stay **Focused on the Ride**

Get 10% OFF any Pivo Pod

| pivoequestrian.com |

WDAE Members Use Code **'WDAAPIVO'**

USEF Members Use Code **'USEF10'**

How To Enter

Step 1: Set-Up Or Confirm Your Account Information

- a) Go to www.spotlighthorsheshows.com.
 - a) If you previously entered a Spotlight Horse Show, please reset your password. Review your account data.
 - b) If you are new to Spotlight Horse Shows, create a new account. You will be asked for your horse, rider, and owner information. That information will now be stored in your profile for easy entry. Your Horse Shows, Videos Signs, and Video Link Status will all be found here on your profile page.

Login

 Remember me

[Forgot your password?](#)
[Register as a new user](#)

Register

Create a new account.

- a) You are now ready to enter a show. The home screen will display currently active shows as well as the division(s) included. Click on a show to enter. You can late enter a show that is already closed, if it is not past the video submission date. A \$25 late fee will automatically be added to your entry. You can also plan ahead by clicking the View Full Calendar Button. Please review the prize list for each show you are entering.

- b) Once you have determined which show you want to enter, click the “Enter Show” Button.

- d) On the left side of the screen, select the competitor and horse for this entry or add a new one.
 e) Select the division(s) you wish to enter.

Spotlight Horse Shows

Home Show Calendar Change Requests Results News Gift Cards My Profile Cart Logout

Select competitor or register new competitor*
 Hunt, Amy

Select horse or register new horse*
 Truman

Select Division(s)
 Dressage Western Dressage Driven Dressage

Would you like others to see your video at the end of the show?
 Yes

Do you want ribbons for this show?
 Yes (To Competitor)

Send ribbons to:
 2061 RS County Road 1330

Selected classes for this competitor/horse

Dressage
 IA-A - Introductory Level, Test A REMOVE

Western Dressage
 No classes yet selected for this division

Class selection for show

Search classes...

Which division?
 Dressage Western Dressage

What type of class?
 Class Champion Class

Which Dressage level?
 Introductory Training TOC

Introductory Level, Test A
 Division: Dressage

Number	Level	Type	Price	
IA-O	Open	Class	\$40.00	ADD

Introductory Level, Test B
 Division: Dressage

Number	Level	Type	Price	
IB-A	Amateur	Class	\$40.00	ADD
IB-O	Open	Class	\$40.00	ADD

Introductory Level, Test C
 Division: Dressage

Number	Level	Type	Price	
IC-A	Amateur	Class	\$40.00	ADD

- f) On the right side of the screen, you will select your classes for each division you have chosen. In this example, you will select classes for Dressage and Western Dressage. Only the classes available to you for the competitor status in your profile (Amateur, Junior, or Open) or Horse Type (Gaited) will show.

Spotlight Horse Shows

Home Show Calendar Change Requests Results News Gift Cards My Profile Cart Logout

Select competitor or register new competitor*
 Hunt, Amy

Select horse or register new horse*
 Truman

Select Division(s)
 Dressage Western Dressage Driven Dressage

Would you like others to see your video at the end of the show?
 Yes

Do you want ribbons for this show?
 Yes (To Competitor)

Send ribbons to:
 2061 RS County Road 1330

Selected classes for this competitor/horse

Dressage
 IA-A - Introductory Level, Test A REMOVE

Western Dressage
 No classes yet selected for this division

Class selection for show

Search classes...

Which division?
 Dressage Western Dressage

What type of class?
 Class Champion Class

Which Dressage level?
 Introductory Training TOC

Introductory Level, Test A
 Division: Dressage

Number	Level	Type	Price	
IA-O	Open	Class	\$40.00	ADD

Introductory Level, Test B
 Division: Dressage

Number	Level	Type	Price	
IB-A	Amateur	Class	\$40.00	ADD
IB-O	Open	Class	\$40.00	ADD

Introductory Level, Test C
 Division: Dressage

Number	Level	Type	Price	
IC-A	Amateur	Class	\$40.00	ADD

- g) Select the division to view your available classes. In this case Example: Dressage. Select the Level with which you will compete. Add each class to your shopping cart by clicking the ADD button on the right.
 h) Once done, select the next division (Western Dressage) and do the same.
 i) Once you have selected all your classes, you are ready to check out. Go to the shopping cart icon and pay for your entry. A \$30 show office fee will automatically be added.
 j) If you have another horse and rider combination to enter, Go back to Show tab, select the show, and do this process again.

Video Signs and Video Links

After signing in, Go to your profile and select your current show. All of your show information will be stored here.

Download Your Video Signs.

If you are using a mobile device, make sure that you have pop-up allowed in your internet browser settings. There is one video sign per class.

US National Dressage Classic - 2025						
Show Entry #: 5392						
Show Horse: Ima Winner						
Show Rider: Jane Smith						
Class	Video Link	Check if Scratched	Video Sign	Score	Place	Test Sheet
T1-A - Training Level, Test 1 - Amateur	SUBMIT LINK	<input type="checkbox"/>	↓ DOWNLOAD	0.000	N/A	N/A
T2-A - Training Level, Test 2 - Amateur	SUBMIT LINK	<input type="checkbox"/>	↓ DOWNLOAD	0.000	N/A	N/A



Entry #
100

Show Name: Pivo Challenge

Rider: Jane Smith

Horse: Ima Winner

Class Number: 33-A: Third Level, Test 3 Amateur

Video Date: _____

Instructions:
Film in landscape position only. Start with the video sign and continuously film. The horse and competitor must be in frame from the start of the test to the end of the equipment check. No editing allowed.
IMPORTANT: Know the rules of your division, including what tack is legal. For additional information on how to video, visit www.spotlighthorsheshows.com/video-rules. Or scan the QR code.



WDA A Show Recognition #25-xxx

Film and Upload Your YouTube Video Links

- Only YouTube video links are accepted.
- Read the video rules and follow them carefully. They do vary by division and show.
- Video rules are located in the prize list. Or, you can use this webpage link www.SpotlightHorseShows/VideoRules. You can also access them via the QR code from your video sign.
- If you do not already have one, create your YouTube channel and upload your videos. There are plenty of tutorials on the web on how to do this. Upload your video to your channel. Be sure to review your video to make sure it is in the correction orientation. **MAKE SURE THEY ARE MARKED PUBLIC OR UNPUBLISHED.**
- Once done, copy and paste the video link to the corresponding class in your Spotlight profile.

US National Dressage Classic - 2025						
Show Entry #: 5392						
Show Horse: Ima Winner						
Show Rider: Jane Smith						
Class	Video Link	Check if Scratched	Video Sign	Score	Place	Test Sheet
T1-A - Training Level, Test 1 - Amateur	SUBMIT LINK	<input type="checkbox"/>	↓ DOWNLOAD	0.000	N/A	N/A
T2-A - Training Level, Test 2 - Amateur	SUBMIT LINK	<input type="checkbox"/>	↓ DOWNLOAD	0.000	N/A	N/A

Video Status and Test Sheets

Check the Status of Your Video.

- Pending means that the video has not yet been reviewed
- Accepted means your video is accepted for judging.
- Not Accepted means there is a problem with your video. If this happens, you will receive notification on steps to correct it.

US National Dressage Classic - 2025							
Show Entry #: 4937							
Show Horse: Ima Winner							
Show Rider: Jane Smith							
Class	Video Status	Video Link	Check if Scratched	Video Sign	Score	Place	Test Sheet
T1-A - Training Level, Test 1 - Amateur	Accepted	View Video	<input type="checkbox"/>	DOWNLOAD	64.8%	2	VIEW SHEET
T2-A - Training Level, Test 2 - Amateur	Accepted	View Video	<input type="checkbox"/>	DOWNLOAD	64.8%	3	VIEW SHEET

Results

View Your Individual Test Sheet and Results

- If you are using a mobile device, make sure that you have popups allowed in your internet browser settings.
- When the judge has completed your test, you will be able to see your score and download a signed copy of the test sheet. If the class has been placed, that will also show.

US National Dressage Classic - 2025							
Show Entry #: 4937							
Show Horse: Ima Winner							
Show Rider: Jane Smith							
Class	Video Status	Video Link	Check if Scratched	Video Sign	Score	Place	Test Sheet
T1-A - Training Level, Test 1 - Amateur	Accepted	View Video	<input type="checkbox"/>	DOWNLOAD	64.8%	2	VIEW SHEET
T2-A - Training Level, Test 2 - Amateur	Accepted	View Video	<input type="checkbox"/>	DOWNLOAD	64.8%	3	VIEW SHEET

View the Show Results

- Once all classes have been judged, the full show results will be on the “Results” tab of the main menu. Use the filters to find your show.

Entry Changes

Any changes must be made via the change form. See the drop down menu of the home page. Changes will be reviewed by management before acceptance. A change fee applies.

NOTE

- Management reserves the right to change officials, combine or cancel classes, and modify the schedule to make whatever changes are required by circumstances to the competition specifications.
- Management reserves the right to refuse or require withdrawal of an entry for cause deemed sufficient by Show Management.

2026

US NATIONAL DRESSAGE CLASSIC ROAD TO THE NATIONAL FINALS

2 Championship Levels

Qualifying Period: August 23, 2025 – August 21, 2026

Semi Finals: Opens 7/24 Closes 8/23. Videos through 9/13

National Finals: Opens 9/25 – 10/18. Videos through 11/8

Qualifying

- Enter any Spotlight Dressage show designated as a qualifier
- Riders who score a minimum of 60% at the highest test of the level are automatically qualified for the **Level Championship** at the on-line Semi-Finals.
- Enter all classes of the level in the same show to be eligible for the **All-Around Championship** for that level. Average score must be a minimum of 60% to advance.
- See list of available classes in prize list.

SEMI-FINALS

- There are 7 regions.
- Riders with the minimum scores of 60% advance to the National Finals for both the Level and All-Around Championships.

Riders can participate in any show qualifier nationwide but will represent their home state in the Semi-Finals

NATIONAL FINALS

- Two Champions per Western Dressage & Dressage Level
 - All-Around Champion
 - Level Champion

**QUALIFIED DRIVEN
DRESSAGE DRIVERS GO
STRAIGHT TO THE
NATIONALS!**

SPOTLIGHT HORSE SHOWS REGIONAL MAP

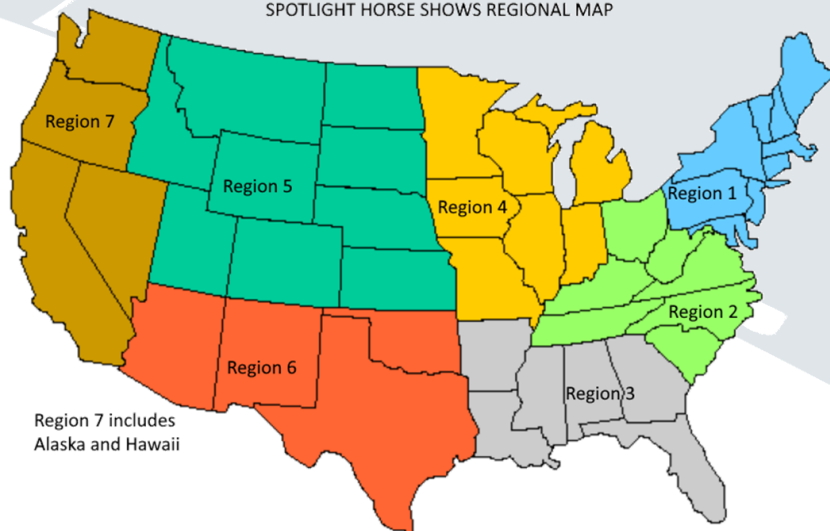

HOW TO ADVANCE TO THE NATIONAL FINALS

Level Championship



1. Ride in the highest test of the level. Get 60% or better (Eventing 40% or lower) and advance to the Semi-Finals

2. Ride the highest test of the level Get 60% or better (Eventing 40% or lower) and advance to the National Finals

3. Ride in the highest test of the level

All-Around Championship

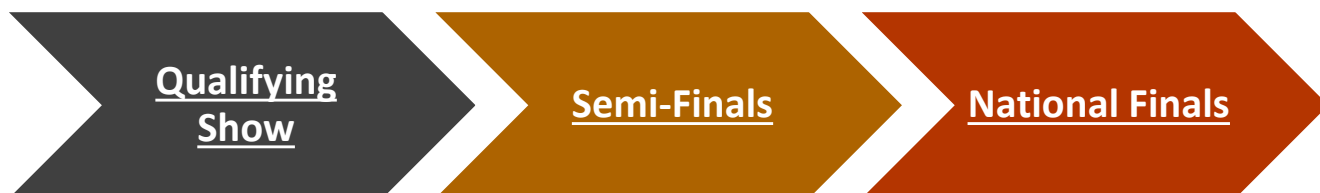

1. Ride all the tests of the level in one show. Get an Average Score of 60% or better (Eventing 40% or lower) and advance to the Semi-Finals

2. Ride all the tests of the level. Get an Average Score of 60% or better (Eventing 40% or lower) and advance to the National Finals

3. Ride all the tests of the level

Awards: Buckles, Plaques, Medallions, Ribbons & More!



* Photos are representative. Actual prizes may vary

Fees and Refunds

DRESSAGE DIVISION FEES	
Introductory – Fourth Level	\$40
Prix St. Georges – Grand Prix	\$40
Musical Freestyle	\$40

EVENTING DIVISION FEES	
All Classes	\$40

WESTERN DRESSAGE DIVISION FEES	
Introductory - Level 5	\$40
Musical Freestyle	\$40

ADMINISTRATIVE FEES	
Show Office Fee	\$30
Horse/Rider/Class Change Fee	\$25
Late Entry Fee	\$25
Insufficient Funds	\$25

- Payment: Entries must be completed online at SpotlightHorseShows.com with online entry form by the closing date.
- Payment is accepted through PayPal or credit card. All fees are in US dollars.
- One show office entry fees allows the same horse and rider team to cross-enter divisions.
- Horse, rider, or class changes are subject to a \$25 change fee.
- Late entries are subject to a \$25 late fee.
- Refunds: Entries canceled for any reason prior to the closing date will be refunded, minus the show office fee. There are no refunds after the closing date. In the event the competition is canceled, Total Entry Fees minus the office fee will be refunded. Thank you for understanding.

Tips on Filming with your Pivo.

Here are some guidelines and links for assistance when using your Pivo.

- Practice with your unit prior to scheduling your film date to determine the best settings and placement for your arena surroundings. Keep note of your preferred settings and camera placement and use them each time you record.
- Check your camera settings.
 - Resolution: 1080p HD settings provide excellent detail for the judges.
 - You can also change the feet per second (fps) recording speed for your recording.
 - Make sure your lens is clean.
- Make sure your camera is level and is vertically plumb in the Pivo unit.
- Make sure the camera is connected to the Pivo unit.
- Refer to the [Pivo Setup Guide for Equestrians](#) for excellent reference materials.
- There are multiple modes for filming, but first try the one Pivo specifically developed for filming online shows.
- Pivo Horse Tracking Tips and Tricks are provided [here](#).
- Riders report good contrasting colors help with tracking
- If you have mirrors in your arena, have the mirrors behind the camera. Or, place the camera at standing eye height to help with tracking.
- You must start your camera when you show the video sign. The video sign may be a sheet of paper that you fold up and put in your pocket or placed on something more firm like a clipboard or transparent folder.
- You should plan on 45 second from the start of your film to when you comes down centerline

If you need further assistance using your Pivo, see the [Pivo Support Page](#) or contact them via their website.

Dressage & Eventing Apparel, Equipment, and Video Rules

Equipment Guidelines

You are responsible for knowing the correct rules for tack and equipment.

If you are familiar with (and follow) USDF tack rules, you will be legal for this show. Here are some important guidelines to follow.

- An English saddle with stirrups is required
- Saddle pads are optional and should be of one conservative color. Accents are allowed.
- Seat covers are not allowed
- No wraps or boots of any kind are allowed above the coronet band
- Bridles with bits are required
- Reins must be used and constructed of leather, leather-like, or webbing. Rubber coated reins and rein steps are allowed.
- One whip of 120 cm (47.2 inches) or shorter is allowed.
- No double bridles at Second Level or below
- Breastplates and cruppers are allowed
- Side reins or other gadgets are not allowed.
- Fly hoods without ear plugs are allowed
- Braiding is not required.

Apparel Guidelines

- Clean, neat, and tidy schooling show dress for qualifier shows is allowed, but full competition dress is required in some shows such as the US National Dressage Classic championship classes. See the prize list for details.
- Jackets are not required. If worn, a short jacket must be used for Fourth Level and below. For FEI classes, a coat with tails is allowed.
- All shirts must have sleeves and some form of collar. T-shirts are not allowed.
- A properly fastened safety helmet is required.
- Vests, rain jackets, or cold weather parkas are allowed.

Video Rules

You may film your ride as soon as you have your sign. Videos must be in focus. Remember, the judge can only score what they can see, so follow these guidelines carefully!

IMPORTANT! Show Management will review all submissions to ensure adherence to the rules as stated below. If a test does not comply with the rules, Show Management will contact the exhibitor immediately via email, text, or phone. The exhibitor will have 48 hours to resubmit their test from the time of the notification. Please take all guidelines into consideration when preparing your test submissions.

- Use arenas that are as close to regulation size as possible and be sure letters are set appropriately to be viewed by the judge. Cones with large letters on them and poles on the ground to delineate the corners are acceptable. Large letters taped on walls work as well. If a test allows for the use of either the large or small arena, you may show in either size.
- To ensure that only videos taped for this competition are used, videos of tests must be unedited from start to finish, starting at the video sign and ending with the equipment check. It must be one continuous recording with the horse and rider visible from the moment they come down centerline. Tests with edits will not be accepted.
- Bridle and saddle pad numbers are not allowed.
- Videos must be filmed in LANDSCAPE orientation.
- The natural background sound for the test must be audible. Tests with no sound will not be accepted.
- Only video links from YouTube will be accepted. Mark the links as either public or unlisted in YouTube.
- The test must be videoed from behind C, where the judge would normally be seated. Try and set the camera 4-5' off the ground. It makes the geometry easier for the judge to see.
- Prior to beginning the ride, a sign must be held up showing the show name, video date (optional), horse & rider names, class # and test description. Remove the sign just before the ride begins.
- Keep the horse in frame, paying close attention to the near corners. On the far side, you will need to zoom in for clearer judging visibility.
- Make sure to keep the letters in the frame that are elements of the test being performed.
- Calling of Tests: The test pattern may be called except for FEI and freestyles rides.
- Coaching during the test is not allowed.
- Equipment Check:
 - As soon as the test is finished, the camera must slowly circle the horse showing the entire side of the horse (including the feet.) Zoom in show details of the spurs and bit/bridle.
 - Show the entire horse, including the legs and feet.
 - Zoom in for 3 seconds so the details of the spurs, bridle and bit are visible.
 - If the videographer is unable to enter the arena, at G the rider may turn the horse slowly, wait five seconds, then turn slowly to show the second side, and wait an additional 5 seconds to complete filming of the equipment.
 - It is permissible to exit the arena for the tack check, as long as the camera stays on the horse the entire time.
 - The rider then dismounts and shows that 2 fingers will fit under the cavesson (noseband) or bosal by the side of the horse's check.

Western Dressage Apparel, Equipment, and Video Rules

Apparel and Equipment

You are responsible for knowing the correct rules for tack and equipment. USEF equipment and apparel rules apply to the Western Dressage division. For a full list of rules, refer to the USEF Rule Book. [CLICK HERE](#) to see the rules.

Video Rules

You may film your ride as soon as you have your sign. Videos must be in focus. Remember, the judge can only score what they can see, so follow these guidelines carefully!

IMPORTANT! Show Management will review all submissions to ensure adherence to the rules as stated below. If a test does not comply with the rules, Show Management will contact the exhibitor immediately via email, text, or phone. The exhibitor will have 48 hours to resubmit their test from the time of the notification. Please take all guidelines into consideration when preparing your test submissions.

- Use arenas that are as close to regulation size as possible and be sure letters are set appropriately to be viewed by the judge. Cones with large letters on them and poles on the ground to delineate the corners are acceptable. Large letters taped on walls work as well. If a test allows for the use of either the large or small arena, you may show in either size.
- To ensure that only videos taped for this competition are used, videos of tests must be unedited from start to finish, including the sign and equipment check and bosal/bridle/bit drop. It must be one continuous recording with the horse and rider visible from the moment they come down centerline. Any video with edits will not be accepted.
- Bridle and saddle pad numbers are not allowed.
- Videos must be filmed in LANDSCAPE orientation.
- The natural background sound for the test must be audible. Tests with no sound will not be accepted.
- Tests with edits will not be accepted.
- Only video links from YouTube will be accepted. Mark the links as either public or unlisted in YouTube.
- The test must be videoed from behind C, where the judge would normally be seated. Try and set the camera 4-5' off the ground. It makes the geometry easier for the judge to see.
- Prior to beginning the ride, a sign must be held up showing the show name, WDAA show recognition number, video date (optional), horse & rider names, class # and test description. Remove the sign just before the ride begins. The videographer can hold the sign then move back to behind the camera or hold the sign in front of the camera at arm's length while also holding the camera.
- Keep the horse in frame, paying close attention to the near corners. On the far side, you will need to zoom in for clearer judging visibility.
- Make sure to keep the letters in the frame that are elements of the test being performed.
- Calling of Tests: The test pattern may be called freestyles rides.
- Coaching during the test is not allowed EXCEPT for WDAA Exceptional Rider tests.
- Equipment Check:
 - As soon as the test is finished, the camera must slowly circle the horse showing the entire side of the horse (including the feet.) Zoom in show details of the spurs and bit/bridle/bosal.
 - Show the entire horse, including the legs and feet.
 - Zoom in for 3 seconds so the details of the spurs, bosal/bridle, and "bit" are visible.
 - If the videographer is unable to enter the arena, at G the rider may turn the horse slowly, wait five seconds, then turn slowly to show the second side, and wait an additional 5 seconds to complete filming of the equipment.
 - It is permissible to exit the arena for the tack check, as long as the camera stays on the horse the entire time.
 - The rider then dismounts and shows that 2 fingers will fit under the cavesson (noseband) or bosal by the side of the horse's check.
 - After putting 2 fingers under the cavesson or bosal the bridle and bit or bosal must be dropped so it can be evaluated. **Exceptional riders** are exempt from the bridle and bit/bosal dropping requirement and are not required to dismount.
 - Hold the bridle still so the bit can clearly be seen (in focus and in frame) for a minimum count of five seconds. Zoom in so details can easily be seen. Make sure the judge can see all parts of the bridle, including bit and reins clearly.
 - Do not to obscure the bit, curb strap, curb chain with your hands. Hold the equipment still for inspection.
 - A cavesson (noseband) must be shown to the camera, both inside and out. Demonstrate flexibility of the cavesson.
 - Demonstrate that the curb strap or chain is flexible and is at least ½ inch wide.
 - Bosal: After you remove the bosal, show both sides of your horse's face, unobstructed, as well as the inside of the bosal. Demonstrate flexibility its flexibility.

Driven Dressage Video Rules

Equipment Guidelines

You are responsible for knowing the American Driving Society (ADS) rules for tack and equipment. If you need a refresher, here is a link to their website. <https://www.americandrivingsociety.org/>

Video Rules

You may film your ride as soon as you have your sign. Videos must be in focus. Remember, the judge can only score what

they can see, so follow these guidelines carefully!

IMPORTANT! Show Management will review all submissions to ensure adherence to the rules as stated below. If a test does not comply with the rules, Show Management will contact the exhibitor immediately via your "My Account" portal of the Spotlight Horse Shows website. The exhibitor will have 48 hours to resubmit their test from the time of the notification. Please take all guidelines into consideration when preparing your test submissions.

- Use arenas that are as close to regulation size as possible and be sure letters are set appropriately to be viewed by the judge. Cones with large letters on them and poles on the ground to delineate the corners are acceptable. Large letters taped on walls or other types of markers work as well. Required ring sizes for the class you are showing in are also included at the ADS website. How to lay out an arena instructions are also included in the show prize list.
- To ensure that only videos taped for this competition are used, videos of tests must be unedited from start to finish, starting at the video sign and ending with final halt and exit out of the arena.
- It must be one continuous recording with the horse and rider visible from the moment they enter the arena. Tests with edits will not be accepted.
- Videos must be filmed in LANDSCAPE orientation.
- The natural background sound for the test must be audible. Tests with no sound will not be accepted.
- Only video links from YouTube will be accepted. Mark the links as either public or unlisted in YouTube prior to uploading your link to your Spotlight Horse Shows portal.
- The test must be videoed from behind C, where the judge would normally be seated. Try and set the camera 4-5' off the ground. It makes the geometry easier for the judge to see.
- Prior to beginning the ride, a sign must be held up showing the show name, video date (optional), competitor and equine names, class # and test description. Remove the sign just before the ride begins. Your video sign can be downloaded from your portal.
- Keep the equine and carriage in frame, paying close attention to the near corners. On the far side, you will need to
- zoom in for clearer judging visibility.
- Make sure to keep the letters in the frame that are elements of the test being performed.
- Coaching during the test is not allowed.

Equipment Check:

The judge will perform the equipment check as part of the judging process.

**IT IS HIGHLY RECOMMENDED THAT YOU MARK X, ESPECIALLY IN THE LARGE ARENAS.
A SMALL PILE OF SHAVINGS WORKS WELL.**

Arena Sizes for Ridden Dressage

For tests allowing for either size arena, you may use either one.

Be aware that some test call for only 1 size arena. In those cases, you must use that. Below are the dimensions needed for you to set up your arena at home.

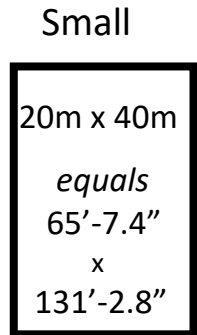
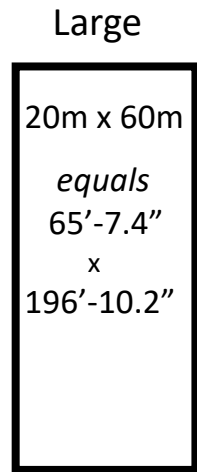
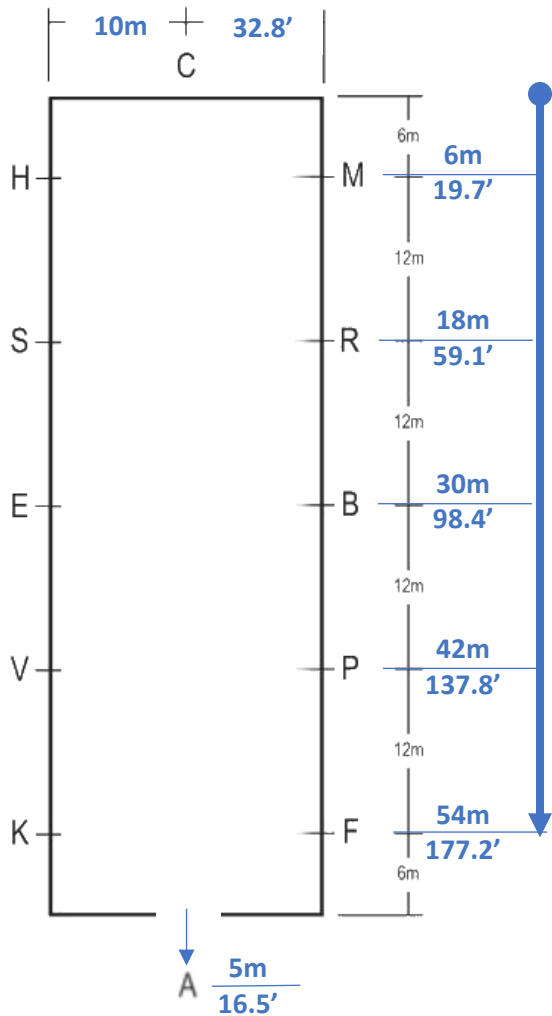

In the LARGE arena:

- Place a mark on the long rail at the following distances from the corner:
 - M: 6m = 19.7'
 - R: 18m = 59.1'
 - B: 30m = 98.4'
 - P: 42m = 137.8'
 - F: 54m = 177.2'
- Place your letters 2 feet from the rail as these marks
- Repeat on the other long side

In the SMALL arena:

- Place a mark on the long rail at the following distances from the corner:
 - M: 6m = 19.7'
 - B: 20m = 65.6'
 - F: 34m = 111.5'
- Place your letters 2 feet from the rail as these marks
- Repeat on the other long side
- C is 10m (or 32.8') in on the short side. Place that letter 2' from the rail as well.

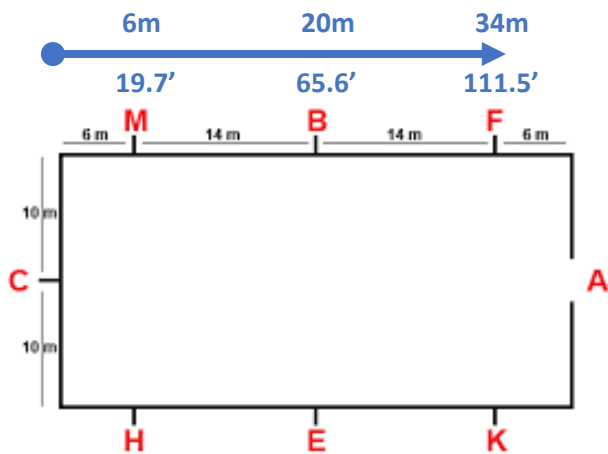

Sport Horse In-Hand Triangle Set-up & Video Rules

Horses will stand in the "open position" for conformation judge both BEFORE and AFTER the walk and trot around the triangle. The entire horse must be in-frame at all times.

Conformation View #1

Before the walk, show the left side of the horse for at least 10 seconds.

Movement Evaluation

Horses will travel to the right (clockwise) around the triangle two (2) times. Be sure to travel on the outside of the cones.

The first circuit will be at the walk and the second time at the trot.

Dependent upon the space available, you have 2 options in which to set up the triangle.

Diagrams and dimensions are picture below.

Conformation View #2

After the trot, show the right side of the horse, plus a view from the back and the front.

The camera can be moved to get the front and back views OR you can reposition the horse.

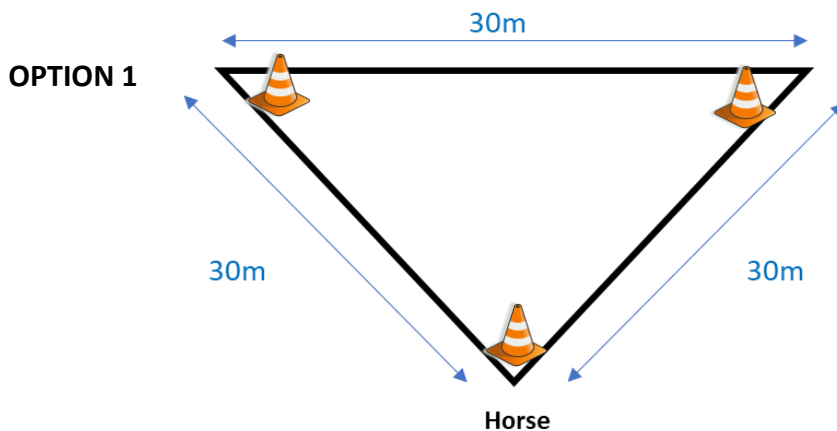

Camera Position

- Place a cone in each corner
- Horse travels clockwise around the outside of the cones.

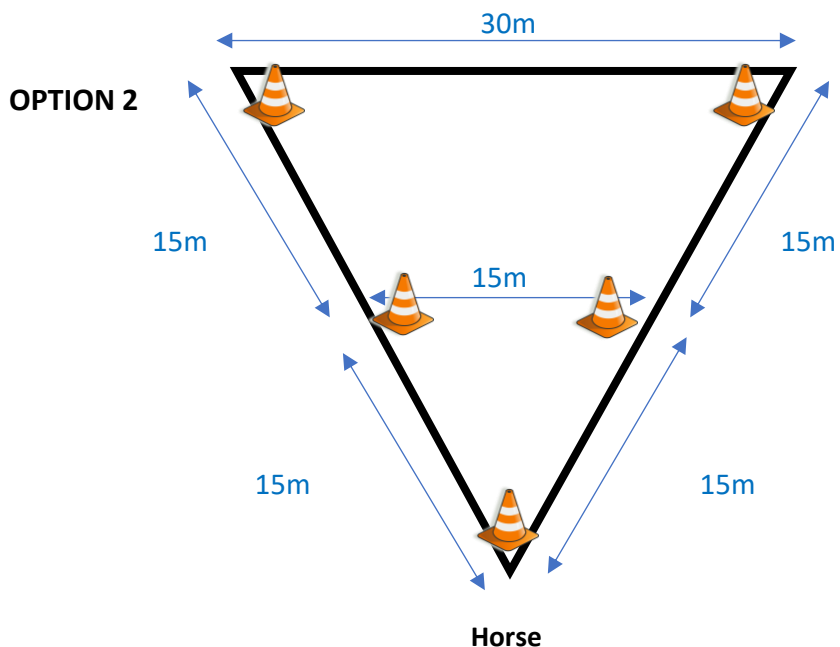

Camera Position

- Place a cone in each corner and midway along each of the left and right sides.
- Horse travels at a walk clockwise around the outside of the cones marking the small 15m triangle.
- Horse then travels at a trot (clockwise) around the outside of the larger triangle.



Setting Up Your DRIVEN Dressage Ring

2-3 people make set-up faster and easier.

Print this guide and take it with you during set-up.

1. Determine where you ring will be placed.

The area should be as flat as possible. If desired, allow additional room to drive around the outside of the ring and for placement of the letters.

2. Gather your tools.

You will need the following:

- Stakes (4)
- Hammer (1)
- Masonry Line (400' for the small ring or 500' for the large ring)
- Tape Measure (min 10' with wide blade)
- Permanent Marker
- Long Tape Measure (300' for the small ring or 350' for the large ring)
- Electrical Tape (optional rail marker)

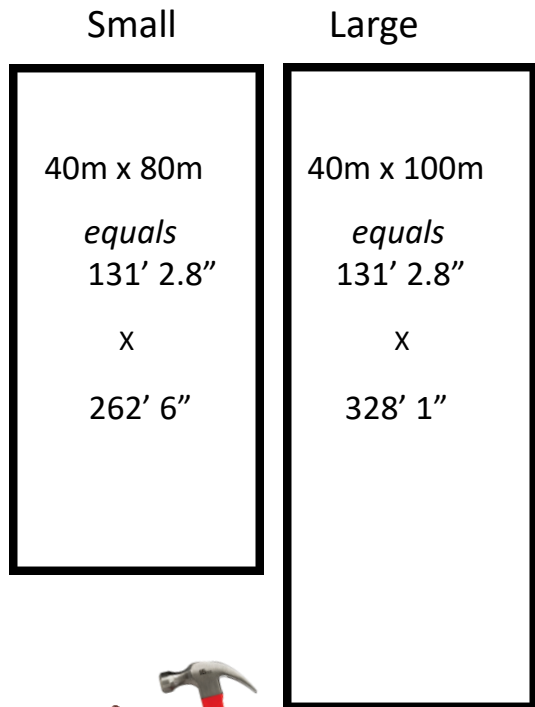

3. Set Your Corners and Rails

- Locate the position of one corner and drive a stake.
- Set the rails using the Pythagorean Theory.
- Mark 1 rail at 6', Mark the 2nd rail at 8'.
- Move the end of the rails until the diagonal line created by the marks equals 10'.

4. Stretch the masonry lines

- Place one along each of the long and short sides and secure to a stake. Place the stakes at the appropriate length of width of the ring you are building.
- Place your rails along these lines.

5. Set Your Next Corner and Rails

- Repeat step 3 & 4 for each of the next corners and sides.

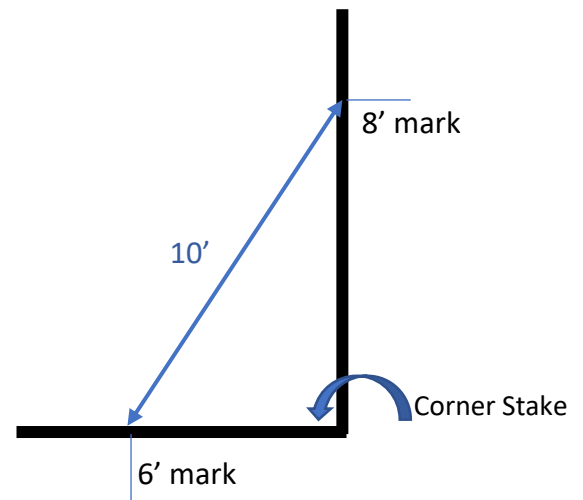

Place The Letters

6a. In the SMALL ring:

- Place a mark on the long rail at the following distances from the corner:
 - M: 10m = 32' 10"
 - B: 40m = 131' 3"
 - F: 70m = 229' 8"
- Place your letters 2 feet from the rail at these marks
- Repeat on the other long side
- C is 20m (or 65' 7") in on the short side. Place that letter 2' from the rail as well.
- A is also 20m (or 65' 7") in on the short side. Place that letter away from the opening

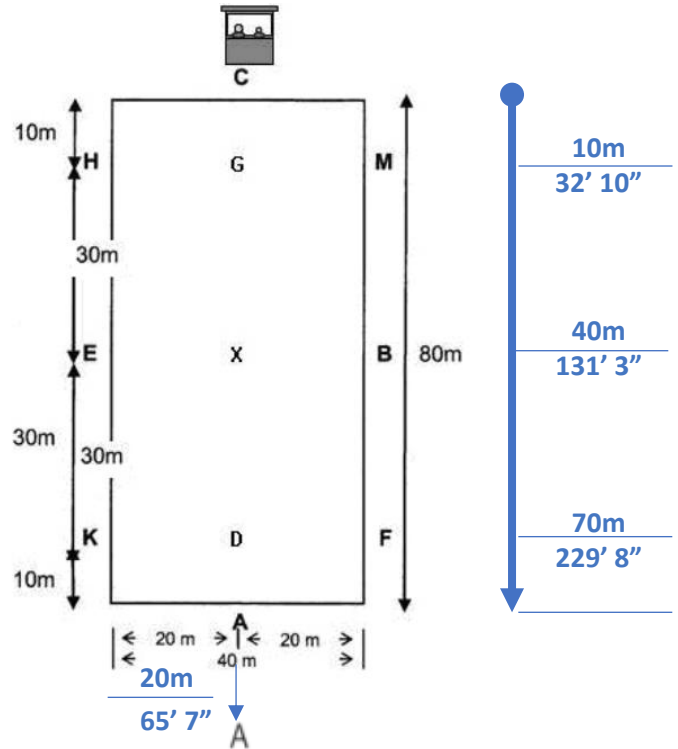

6b. In the LARGE ring:

- Place a mark on the long rail at the following distances from the corner:
 - M: 10m = 32' 10"
 - R: 30m = 98' 5"
 - B: 50m = 164' 1"
 - P: 70m = 229' 8"
 - F: 90m = 295' 3"
- Place your letters 2 feet from the rail as these marks
- Repeat on the other long side
- C is 20m (or 65' 7") in on the short side. Place that letter 2' from the rail as well.
- A is also 20m (or 65' 7") in on the short side. Place that letter away from the opening

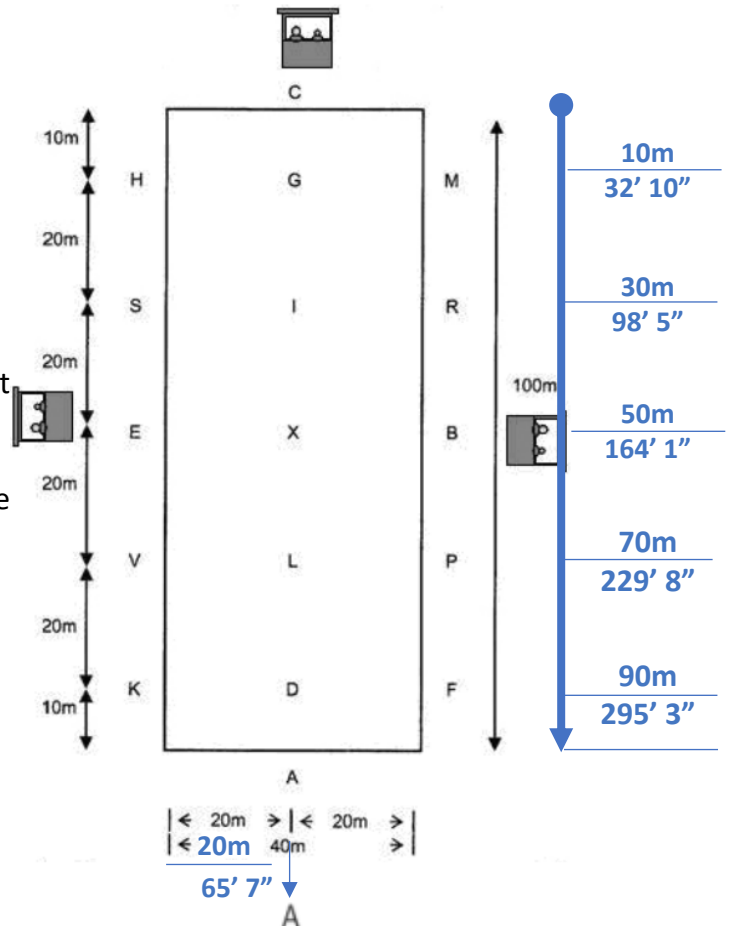

7. HINT: Mark the Rails (Optional):

Mark the letter points on the rails with a contrasting color of tape for more precision riding.

Amateur Status Declaration

To compete in Amateur classes in the Western Dressage Division, competitors are required to provide proof of Amateur status in one of three ways. Declaration can be made at www.spotlighthorshes.com

1. Submit a copy of amateur card from a recognized equestrian sports governing organization (USEF, AQHA, APHA etc.)

2. Attest that you are serving an internship for college credit through your respective accredited college program and have never held professional status.

3. Attest that you meet the qualifications below.

I attest that, after my 18th birthday, I have not:

- a) Accepted remuneration for riding, driving, showing, training, schooling, or conducting clinics or seminars.
- b) Accepted remuneration for giving riding or driving lessons, lessons in showmanship, instructions in equitation or horse training. (Persons acting as counselors at summer camps, who are not hired in the exclusive capacity of riding instructors, are excluded and persons giving instructions and training to the handicapped are also excluded).
- c) Accepted remuneration AND acted as an agent in the sale of a horse or pony or accepted a horse or pony on consignment for the purpose of sale or training that is not owned by me, my cohabitant, or family member, a farm/ranch/syndicate/partnership/corporation/business I, my cohabitant or family member controls.
- d) Accepted remuneration for the use of my name, photograph or other form of personal association as a horseman in connection with any advertisement or article to be sold.
- e) Accepted prize money in equitation or showmanship classes, except in amateur or owner classes.
- f) Advertised my professional services such as training or giving lessons by way of business cards, print ads, or internet. Exception: The writing of books or articles pertaining to horses.
- g) Accepted a token of appreciation, other than money, for riding, driving, or showing in hand in halter (tokens worth more than \$300 are considered remunerations)

Junior Status

Riders are eligible to compete as juniors if they are 17 years of age or less at the beginning of the competition year (which begins December 1st of the prior calendar year).

Open Classes

Any horse or rider may enter an open class if a junior or Amateur class is not available for that test. Example: Musical Freestyles are Open classes where Juniors, Amateurs, and Professionals compete together.

Any rider with a Professional rating may not enter Junior or Amateur classes.

DRESSAGE DIVISION CLASS LIST

Qualifier for the US National Dressage Classic Semi-Finals

To compete for a spot in the Semi-Finals:

- Enter all tests of the level to be eligible for the All-Around
- Enter the highest test of the level try for a spot in the Level Championship



Description	Open	Amateur	Junior
Introductory Level, Test A	IA-O	IA-A	IA-J
Introductory Level, Test B	IB-O	IB-A	IB-J
Introductory Level, Test C	IC-O	IC-A	IC-J
Training Level, Test 1	T1-O	T1-A	T1-J
Training Level, Test 2	T2-O	T2-A	T2-J
Training Level, Test 3	T3-O	T3-A	T3-J
1st Level, Test 1	11-O	11-A	11-J
1st Level, Test 2	12-O	12-A	12-J
1st Level, Test 3	13-O	13-A	13-J
2nd Level, Test 1	21-O	21-A	21-J
2nd Level, Test 2	22-O	22-A	22-J
2nd Level, Test 3	23-O	23-A	23-J
3rd Level, Test 1	31-O	31-A	31-J
3rd Level, Test 2	32-O	32-A	32-J
3rd Level, Test 3	33-O	33-A	33-J
4th Level, Test 1	41-O	41-A	41-J
4th Level, Test 2	42-O	42-A	42-J
4th Level, Test 3	43-O	43-A	43-J
Freestyle, Training Level	FS-T	Enter as Open	Enter as Open
Freestyle, First Level	FS-1	Enter as Open	Enter as Open
Freestyle, Second Level	FS-2	Enter as Open	Enter as Open
Freestyle, Third Level	FS-3	Enter as Open	Enter as Open
Freestyle, Fourth Level	FS-4	Enter as Open	Enter as Open
Freestyle, FEI (TOC)	FS-FEI	Enter as Open	Enter as Open
Prix St. Georges	PSG	Enter as Open	Enter as Open
Intermediare (TOC)	INTER	Enter as Open	Enter as Open
Grand Prix (TOC)	GP	Enter as Open	Enter as Open
FEI (TOC)	FEI-TOC	Enter as Open	Enter as Open
Dressage (TOC)	DSG-TOC	Enter as Open	Enter as Open
PARA (TOC)	PARA	Enter as Open	Enter as Open
PARA Freestyle	PARA-FS	Enter as Open	Enter as Open
Sport Horse In-Hand (TOC)	SHP	Enter as Open	Enter as Open
Developing Horse (TOC)	DH	Enter as Open	Enter as Open
Young Horse (TOC)	YH	Enter as Open	Enter as Open
Dutch Z1 Test 38	Z1-38	Enter as Open	Enter as Open
Dutch Z1 Test 39	Z1-39	Enter as Open	Enter as Open
Dutch Z1 Test 40	Z1-40	Enter as Open	Enter as Open
Dutch Z1 Test 41	Z1-41	Enter as Open	Enter as Open

WESTERN DRESSAGE DIVISION CLASS LIST

Qualifier for the US National Dressage Classic Semi-Finals

To compete for a spot in the Semi-Finals:

- Enter all tests of the level to be eligible for the All-Around
- Enter the highest test of the level try for a spot in the Level Championship



Description	Exceptional	Open	Amateur	Junior	Gaited
Horsemanship, Walk-Jog - Pattern B		HWJ	Enter as Open	Enter as Open	Enter as Open
Horsemanship, Intermediate - Pattern B		HI	Enter as Open	Enter as Open	Enter as Open
Horsemanship, Advanced - Pattern B		HA	Enter as Open	Enter as Open	Enter as Open
Introductory Level, Test 1		INT1-O	INT1-A	INT1-J	INT1-G
Introductory Level, Test 2		INT2-O	INT2-A	INT2-J	INT2-G
Introductory Level, Test 3		INT3-O	INT3-A	INT3-J	INT3-G
Introductory Level, Test 4		INT4-O	INT4-A	INT4-J	INT4-G
Basic Level, Test 1		BT1-O	BT1-A	BT1-J	BT1-G
Basic Level, Test 2		BT2-O	BT2-A	BT2-J	BT2-G
Basic Level, Test 3		BT3-O	BT3-A	BT3-J	BT3-G
Basic Level, Test 4		BT4-O	BT4-A	BT4-J	BT4-G
Level 1, Test 1		L1T1-O	L1T1-A	L1T1-J	L1T1-G
Level 1, Test 2		L1T2-O	L1T2-A	L1T2-J	L1T2-G
Level 1, Test 3		L1T3-O	L1T3-A	L1T3-J	L1T3-G
Level 1, Test 4		L1T4-O	L1T4-A	L1T4-J	L1T4-G
Level 2, Test 1		L2T1-O	L2T1-A	L2T1-J	L2T1-G
Level 2, Test 2		L2T2-O	L2T2-A	L2T2-J	L2T2-G
Level 2, Test 3		L2T3-O	L2T3-A	L2T3-J	L2T3-G
Level 2, Test 4		L2T4-O	L2T4-A	L2T4-J	L2T4-G
Level 3, Test 1		L3T1-O	L3T1-A	L3T1-J	L3T1-G
Level 3, Test 2		L3T2-O	L3T2-A	L3T2-J	L3T2-G
Level 3, Test 3		L3T3-O	L3T3-A	L3T3-J	L3T3-G
Level 3, Test 4		L3T4-O	L3T4-A	L3T4-J	L3T4-G
Level 4, Test 1		L4T1-O	L4T1-A	L4T1-J	L4T1-G
Level 4, Test 2		L4T2-O	L4T2-A	L4T2-J	L4T2-G
Level 4, Test 3		L4T3-O	L4T3-A	L4T3-J	L4T3-G
Level 4, Test 4		L4T4-O	L4T4-A	L4T4-J	L4T4-G
Level 5, Test 1		L5T1-O	L5T1-A	L5T1-J	L5T1-G
Level 5, Test 2		L5T2-O	L5T2-A	L5T2-J	L5T2-G
Level 5, Test 3		L5T3-O	L5T3-A	L5T3-J	L5T3-G
Level 5, Test 4		L5T4-O	L5T4-A	L5T4-J	L5T4-G
Freestyle, Intro Level		WDFS-IN	Enter as Open	Enter as Open	Enter as Open
Freestyle, Advanced Walk/Jog		WDFS-AWJ	Enter as Open	Enter as Open	Enter as Open
Freestyle, Basic Level		WDFS-B	Enter as Open	Enter as Open	Enter as Open
Freestyle, Level 1		WDFS-1	Enter as Open	Enter as Open	Enter as Open
Freestyle, Level 2		WDFS-2	Enter as Open	Enter as Open	Enter as Open
Freestyle, Level 3		WDFS-3	Enter as Open	Enter as Open	Enter as Open
Freestyle, Level 4		WDFS-4	Enter as Open	Enter as Open	Enter as Open
Freestyle, Level 5		WDFS-5	Enter as Open	Enter as Open	Enter as Open
CFS-I5: Costume Freestyle Level of Choice		CFS-I5	Enter as Open	Enter as Open	Enter as Open
Western Dressage Test of Choice		WD-TOC	Enter as Open	Enter as Open	Enter as Open
Leadline A Walk Only	ER-LAW	n/a	n/a	n/a	n/a
Leadline A	ER-LA	n/a	n/a	n/a	n/a
Leadline B	ER-LB	n/a	n/a	n/a	n/a
Coached Test, Test 1 Walk Only	C-1WO	n/a	n/a	n/a	n/a
Coached Test, Test 1	C1	n/a	n/a	n/a	n/a
Coached Test, Test 2	C2	n/a	n/a	n/a	n/a
Coached Test, Test 3	C3	n/a	n/a	n/a	n/a
Physically Challenged (Test of Choice #1)	PC-TOC1	n/a	n/a	n/a	n/a
Physically Challenged (Test of Choice #2)	PC-TOC2	n/a	n/a	n/a	n/a
Physically Challenged (Test of Choice #3)	PC-TOC3	n/a	n/a	n/a	n/a
Physically Challenged (Test of Choice #4)	PC-TOC4	n/a	n/a	n/a	n/a

EVENTING DRESSAGE DIVISION CLASS LIST

Qualifier for the
US National Dressage Classic Semi-Finals



Description	Open	Amateur	Junior
Starter	ST-O	ST-A	ST-J
Beginner Novice, Test A	BNA-O	BNA-A	BNA-J
Beginner Novice, Test B	BNB-O	BNB-A	BNB-J
Novice, Test A	NA-O	NA-A	NA-J
Novice, Test B	NB-O	NB-A	NB-J
Novice Three-Day	N3-O	N3-A	N3-J
Training, Test A	TA-O	TA-A	TA-J
Training, Test B	TB-O	TB-A	TB-J
Training Three-Day	T3D-O	T3D-A	T3D-J
Preliminary, Test A	PA-O	PA-A	PA-J
Preliminary, Test B	PB-O	PB-A	PB-J
Preliminary, Test C	PC-O	PC-A	PC-J
Preliminary Three-Day	P3-O	P3-A	P3-J
Intermediate, Test A	IntA-O	IntA-A	IntA-J
Intermediate, Test B	IntB-O	IntB-A	IntB-J
Intermediate, Test C	IntC-O	IntC-A	IntC-J
Advanced, Test A	AA-O	AA-A	AA-J
Advanced, Test B	AB-O	AB-A	AB-J
Modified, Test A	MA-O	MA-A	MA-J
Modified, Test B	MB-O	MB-A	MB-J
Modified, Test C	MC-O	MC-A	MC-J
Modified Three Day	M3-O	M3-A	M3-J
ED-TOC	ED-TOC	Enter as Open	Enter as Open

WESTERN DRESSAGE ASSOCIATION®

OF AMERICA

GUIDELINES FOR GAITED HORSES

There are a significant number of gaited horse breeds (about 30 in North America), all with gaits specific to their breed. In Western Dressage competition, the gaited horse will perform a saddle gait in place of the jog. The saddle gait selected should be the gait in which the horse is balanced and athletically comfortable performing. The saddle gait is a 4 beat lateral or diagonal gait, timely and evenly performed. The tempo, rhythm and foot falls of the gait they choose to show must not change throughout the test. The true four beat gait the horse performs, should be able to be ridden in a working, lengthened, free and collected manner as the Western Dressage test calls for.

All rules can be found in the USEF Rule Book under Western Dressage.

WD106 Saddle Gait

The saddle gait has a noticeable increase in cadence from the working walk. Excessive speed or slowness will be penalized.

1. In lieu of a jog, gaited horses perform gaits of various rhythms and footfalls. The gaited horse will perform a saddle gait in place of the jog.
2. The saddle gait may be either a lateral or diagonal gait, timely and consistently performed. The tempo, rhythm and foot falls of the gait the rider chooses to perform must not change throughout the test. The gait the horse performs, should be able to be ridden in a working, lengthened, free and collected manner as the Western Dressage test specifies.
3. The quality of the saddle gait is judged by general impression, i.e. the regularity and rhythm of the steps, the cadence and impulsion. This quality originates from the horse having a supple back and well engaged hind quarters, and the ability to maintain the same rhythm and natural balance in all variations of the saddle gait.
 - a. Collected Saddle Gait. The horse, remaining “on the bit”, moves forward with the neck raised and arched and showing clear self-carriage. The head approaches the vertical position and a light contact is maintained with the mouth. The hocks are well-engaged and must maintain an energetic gliding impulsion, enabling the shoulders to move more freely. Although the horse’s steps are shorter than in the other saddle gaits, elasticity and cadence are not lessened.
 - b. Working Saddle Gait. With an energetic, regular consistent rhythm; the horse must go forward with consistent and elastic steps. The back must be relaxed and the shoulders free, while there is an obvious push from the hindquarters. The hind legs actively glide under the horse. The horse must show proper balance and maintain light contact with the bit. The horse’s nose must be on or slightly in front of the vertical.
 - c. Lengthening of Stride. This is a variation of the Working saddle gait; the horse covers more ground while maintaining the same tempo, consistent rhythm as in the Working saddle gait. Speeding up is a fault.
 - d. Free Saddle Gait. The Free saddle gait will show moderate lengthening of stride and frame compared to the Working saddle gait. Without hurrying, the horse goes forward with clearly lengthened steps, with impulsion from the hindquarters and uphill balance. The rider allows the horse to carry the head a little more in front of the vertical than at the Collected and the Working saddle gait. The horse’s neck is “out”, down and forward, with the nose slightly in front of the vertical, with a loose rein and the poll at approximately the same height as the wither (the neck is level). The steps should be consistent, the whole movement balanced and unconstrained, while maintaining a consistent rhythm.



Western Dressage Association® of America (WDA)

P.O. Box 2349 Parker, CO 80134

www.WesternDressageAssociation.org

info@westerndressageassociation.org

FREISIAN HORSE ASSOCIATION OF NORTH AMERICA



ONLINE SHOW SUBMISSIONS

Up to 2 Spotlight Horse Show tests may be submitted. Only Spotlight Horse Show results may be submitted.

PERFORMANCE AWARDS [Click this link for more information and forms](#)

Divisions included in this show are: Dressage, Western Dressage, and Driven Dressage

Dressage: All tests Introductory through FEI levels approved. Musical Freestyle approved

Western Dressage: All tests Introductory through Level 5 approved. Musical Freestyle approved

Driven Dressage: All tests

FHANA's Performance Awards are designed to reward FHANA members who are excelling in their equestrian discipline. There are nine (9) FHANA Performance Awards: Ridden Dressage, Riding, Driving, Driven Dressage, Western Dressage, In-Hand, Youth Dressage, Youth Driving, and Youth Riding. In 2019 FHANA implemented performance awards at the regional level, which allows for 7 different winners in those 9 different disciplines. Each regional winner is recognized with an award during the FHANA Annual General Meeting, and the overall winner for each discipline will be the highest scoring regional winner and become a FHANA Champion for the year. The 9 Champions will have their names placed on their discipline's perpetual trophy that is currently displayed in the FHANA office.

Please refer to the map to the [map](#) on the FHANA website to determine your FHANA region.

SPORT PREDICATE TITLES [Click this link for more information and forms](#)

The Sport predicate can be awarded to mares, gelding, and stallions that achieve good results in competitive sport. Sport can only be earned based on results achieved at shows registered with the "United States Equestrian Federation [USEF], United States Dressage Federation [USDF], Equestrian Canada, American Driving Society [ADS], Koninklijke Nederlands Hippische Sportfederatie/Royal Dutch Equestrian Federation (KNHS), and Spotlight Horse Shows [SHS]. The scores registered with USEF, USDF, ADS, Equestrian Canada, KNHS, and SHS determine qualification for the Sport predicate.

Divisions included in this show are Dressage and Driven Dressage.

Dressage: Scores must be from a test Third Level or higher

Driven Dressage: Scores must be from a single horse FEI test or any single horse Advanced ADS test with a canter movement

SPOTLIGHT HORSE SHOWS WILL PROVIDE A COPY OF YOUR VIDEO LINK TO FHANA AT THE COMPLETION OF THE SHOW. VIDEOS MAY BE UTILIZED FOR EDUCATIONAL AND PROMOTIONAL PURPOSES.



Paint Alternative Competition Program (PAC)

Description

Through the Paint Alternative Competition Program (PAC), you can get recognition for accomplishments in competitive events. PAC rewards your Paint's accomplishments in events outside of traditional breed shows. Results from events like open and 4-H shows, barrel races, team pennings, ropings, horse trials, dressage shows and more become PAC credits that help your Paint earn an official APHA performance record along with year-end and perpetual awards.

See the full program at APHA.com.

Easy to Enroll

- Owner & exhibitor/rider must be a current APHA or AjPHA member
- Individual memberships must be used for the exhibitor/rider, joint or ranch memberships cannot.
- Participants do not have to own the horse
- Ride or drive an APHA horse—Regular or Solid Paint-Bred Registry
- Horse must be enrolled online. Enrollments will not be accepted through any other channel.
- All enrollments expire on December 31 of the enrollment year.
- Horse must be enrolled in PAC before Exhibitor Reports or Riding Logs can be submitted.

Awards

- Certificate of Recognition: A minimum of 20 PAC credits in any one approved category
- Certificate of Achievement: 60 or more PAC credits in any one approved category
- PAC Year-End awards are presented to the top 5 horses who earn the most credits in one category along with recognition in the Paint Horse Journal.
- Six PAC Top Five awards go to the top five horses earning credits in at least six different categories in both Open and Youth categories.
- Additional awards categories are on the APHA website.

PAC Categories in this Show

Dressage – Includes Dressage, Western Dressage, and Eventing Dressage

**For more information on joining PAC, call (817) 834-2742
or e-mail pac@apha.com.**

Spotlight Horse Shows Gives Back to the Community

The Dressage Foundation

As a corporate sustaining partner for The Dressage Foundation, our monthly donations help fund this non-profit organization. Excellent grant opportunities and funding for local clinics. Full grant and clinic opportunity information are available at dressagefoundation.org.

Western Dressage Affiliates

Western Dressage affiliates who host a show receive a portion of the proceeds. They utilize these funds to support their club awards, purchase equipment, and expand on local learning opportunities.

Dressage Group Member Organizations (GMOs)

Dressage GMO's who host a show receive a portion of the proceeds. They utilize these funds to enhance the club's myriad of efforts to bring dressage to their members.

Breed Awards Spotlight Horse Shows works with breed organizations to help make breed awards available to those who show online. If you are a member of a breed organization and would like information on how online shows could work for you, please contact Gail Matheus at Gail@SpotlightHorseShows.com.

Sponsorships

If you would like to market your equestrian related company, please contact Gail Matheus at Gail@SpotlightHorseShows.com



"I have always been so very impressed with the work that The Dressage Foundation does. They make a tangible difference in the lives of their grant and scholarship recipients. It is a top-notch organization and one that we want to support."

Gail Matheus, Spotlight Horse Shows
Spotlight Horse Shows, a division of Stonegate, LLC, is a
Corporate Sustaining Partner of The Dressage Foundation.